

APEX TVL Vertical Trunk Pump

The Apex Pumps TVL range of pumps are vertical trunk pumps for mounting into a tank, pit or sump. The pumps can be designed to fit onto any tank top forming part of the lid. The shaft is supported by a thrust bearing at the top of the shaft and by a product lubricated synthetic sleeve bearing adjacent to the impeller with further lubricated line shaft bearings as required.

FEATURES

- ◆ Designed and engineered to the customers requirement
- ◆ ATEX Directive 2014/34/EU option available

BENEFITS

- ◆ Comprehensive range available
- ◆ Impellers trimmed to contract duty
- ◆ Customisable sole plate to fit all tank tops
- ◆ Supplied with IE3 motors for energy saving
- ◆ Semi open vortex impellers also available

OPERATING RANGE

- ◆ Maximum flow rates up to 1080 m³/hr
- ◆ Discharge flange sizes 32mm – 250mm
- ◆ Flange ratings
BS4504 PN16, BS4504 PN25, BS4504 PN40, ANSI
150RF or 300RF

APPLICATIONS

- water supply
- Cooling water
- Air conditioning
- Heating circulation
- Industrial liquids chemicals
- Seawater
- Oils solvents and process liquids
- Aqua-culture
- Electroforetic paint

WORKING PRESSURE

Cast Iron pumps are capable of a 12 Bar working pressure. Higher rated flanges, cast steel and stainless steel pumps can be supplied for higher working pressures. All pumps are hydrostatically tested to 1.5 times the rated working pressure.

SPARE PARTS

All TD pumps are fully supported by Apex Pumps dedicated spares team.
Contact: spares@apexpumps.com

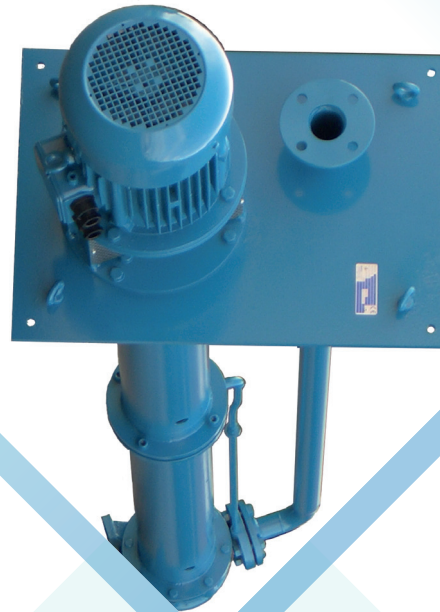

MATERIALS

Castings in a variety of materials are produced in the company's own ISO 9001 foundry in Bristol, using the Replicast method to produce porosity free castings by shell moulding. Castings can meet NORSOK and NACE MR0103 standards where required.

Cast Iron

BS-1561:2011

Stainless Steel

ASTM A351 CF8M, CF3M, CF8, CF3

Other grades available on request.

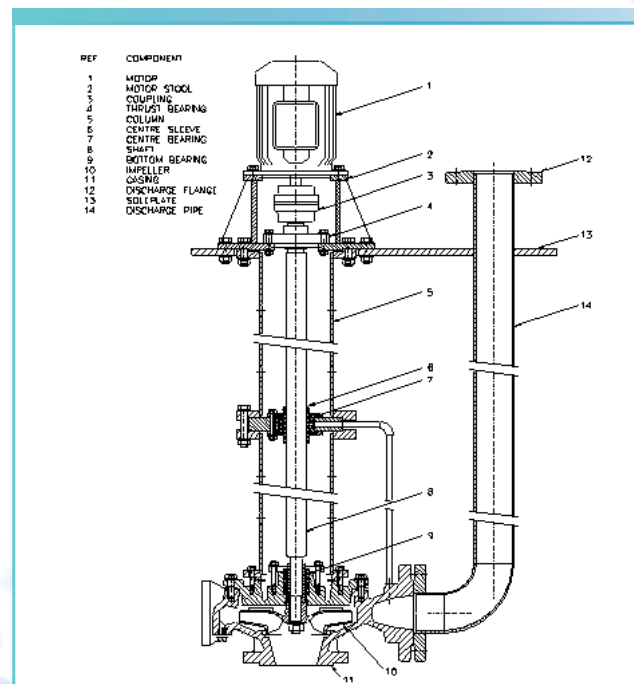

APEX TVL Range Charts 50hz

